

*Hydraulic press
brakes*

PPEB SERIES

CONFIGURED TO YOUR NEEDS

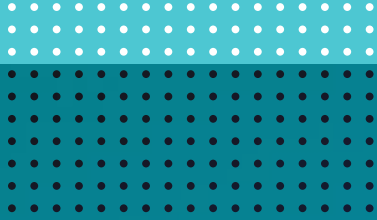

PPEB SERIES

CONFIGURED TO YOUR NEEDS

PPEB press brakes offer precision bending in a flexible design. You configure a PPEB to suit your requirements – choose your backgauge, increase the distance between table and ram, integrate a robot interface, horn extensions or CNC sheet supports. The options are numerous. Whether your application is simple or complex, a PPEB is designed to specifically address your production needs in a press brake that is proven accurate and reliable.



USER-FRIENDLY TOUCH SCREEN CONTROL

The 19" Touch-B control is intuitive and easy-to-use.

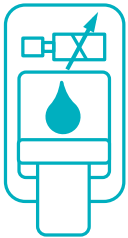

ACCURATE HYDRAULIC SYSTEM

Manufactured in-house by LVD, the servo-controlled hydraulic system delivers power efficiency and high accuracy in a field-proven design.



ROBUST FRAME

PPEB models up to 400 ton/4m have a one-piece welded frame that can be installed at floor level. Longer bed lengths and higher pressing forces may require modified floor arrangements.





TAILOR-MADE

Numerous options ensure that your PPEB completely matches your application requirements: increased distance table-ram, wider table, hydraulic clamping, and many more.



STATUS LIGHTING

LED lights indicate the machine status.

AUTOMATIC CROWNING



Standard on PPEB-5 and PPEB-8 models, the crowning system ensures parallel bending every time.

LINEAR ENCODERS



Referenced encoders are connected to the bed in such a way that deformation during bending does not influence the positioning accuracy of the ram.



BACKGAUGE SYSTEM

The 2-, 5- or 6-axis backgauge is automatically positioned for optimum bending results.

CNC CROWNING

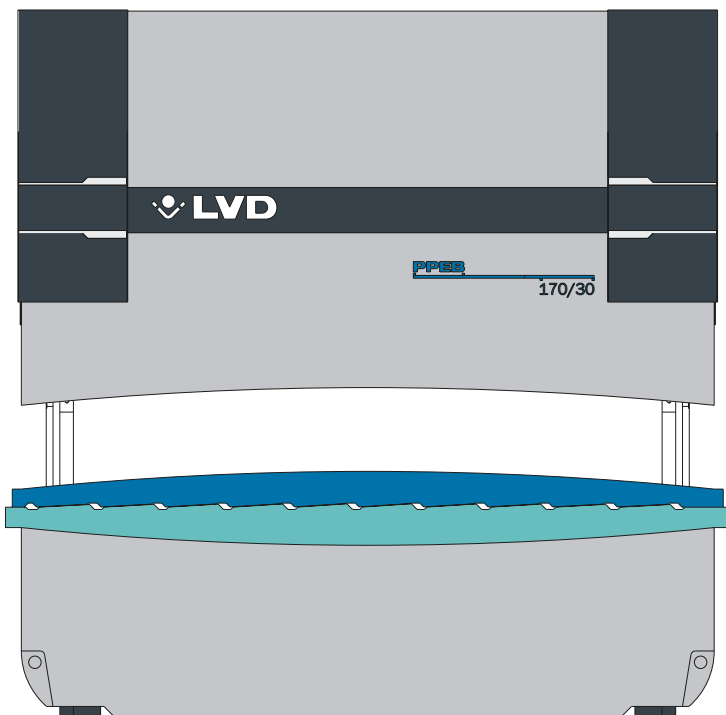
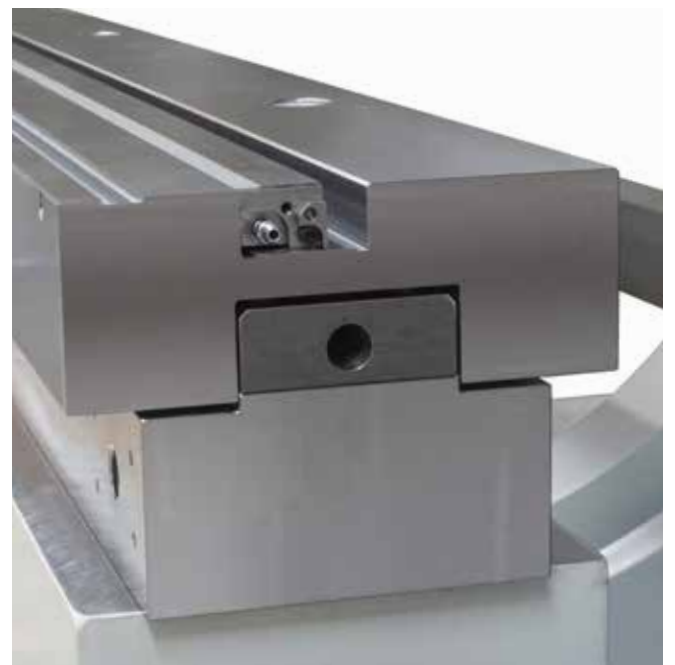

Fig. b

The servo-hydraulic system ensures that the piston at each end of the ram reaches the programmed position established in the Touch-B control. This assures a correct bend angle under the piston.

Press brakes have a natural tendency to deflect under load, particularly in the center between the pistons. As a result, without intervention, the bend angle will vary over the length of the press brake. To compensate for this problem, PPEB press brakes are equipped with a tailor-made crowning device which consists of two rows of wedges. The crowning device is controlled through the Touch-B control and compensates for the bed deflection and the ram under different bending forces.

The crowning device is tailor-made for each individual machine. The associated components are machined and finished following the geometrical measurement between the ram and lower frame.



FLEXIBLE BACKGAUGE SYSTEM

A solidly constructed, two-axis backgauge allows precise depth (X-axis) and height (R-axis) positioning of the two standard backgauge fingers. PPEB-8 models offer the additional flexibility of Z1 and Z2 motorized backgauge movement.

The standard PPEB backgauge fingers allow gauging to 39.3" (1000 mm) and also serve as material supports. PPEB-4 and PPEB-5 can be equipped with an additional third finger, ideally suited to the bending of omega and other similar profiles.

	PPEB-4	PPEB-5	PPEB-8
X-R	X	X	
X-R-Z1-Z2-X'			X

Standard two-axis backgauge (X, R) with manual Z-axis on PPEB-4 and PPEB-5



Optional modular backgauge (X1, R1, Z1 - X2, R2, Z2) up to 400 T on PPEB-8



Five-axis backgauge (X, R, Z1, Z2, X') on PPEB-8

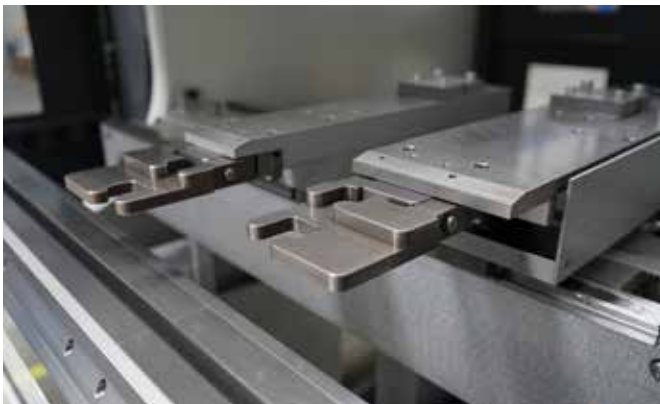

Modular backgauge (X1, R1, Z1 - X2, R2, Z2) for 500 T and 640 T on PPEB-8



WIDE RANGE OF CAPACITIES



PPEB 80/15



PPEB 135/30





TANDEM

PPEB 320/51



100 WAYS TO CONFIGURE YOUR PRESS BRAKE

There are numerous ways to configure a PPEB according to your needs. Select the stroke and table-ram distance. Choose a wider table for multi-V dies or quick-acting hydraulic clamping on the table. Add an interface for a robot

connection, turbo technology, barcode scanner, oil cooler with air or air conditioner for the electrical cabinet. You can even designate a special color, add a second remote console, and more.



Wider table for use of multi-V dies



Front supports on guide rails allow quick positioning along the entire bending length



Two programmable sheet followers



Extended parking zone left/right



Increased table-ram/stroke/gap distance in 3.93" (100 mm) steps



Quick-acting hydraulic clamping on ram and on table



LED lights on front and back side



Additional backgauge finger for gauging long, small strips

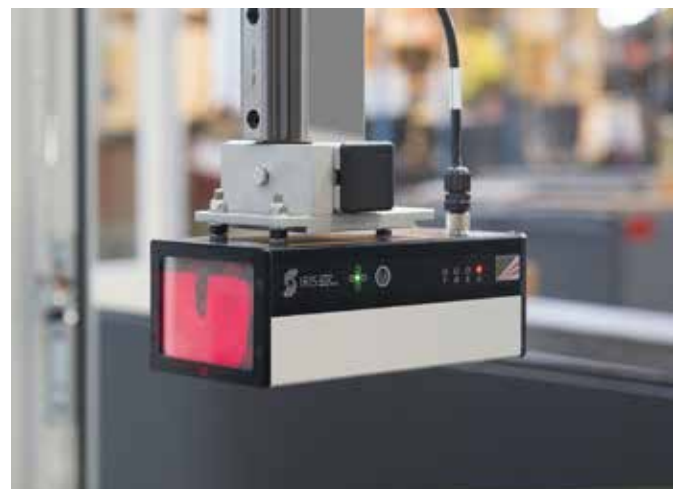

Lazersafe safety system



Special color

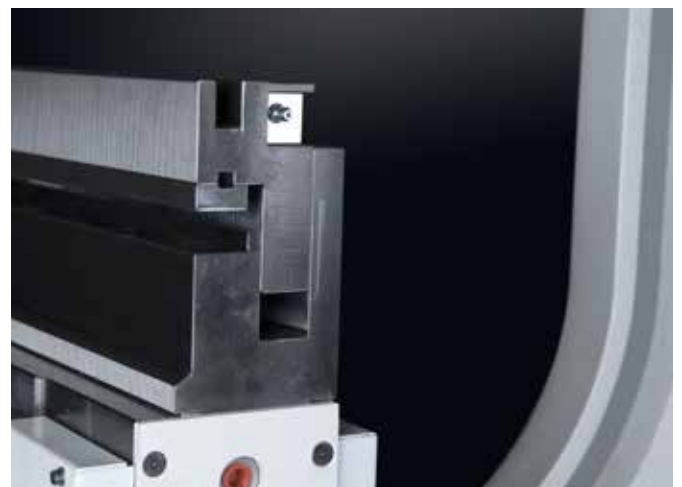

Hemming table

TECHNICAL SPECIFICATIONS

Type		80/15	80/20	80/25	80/Turbo	110/30	110/40	110/42	110/Turbo	135/30	135/40
Pressing force	Ton	90	90	90	90	120	120	120	120	150	150
Pressure	Bar	290	290	290	290	245	245	245	245	290	290
Working length	A Inch	59	78	98		120	157	168		120	157
Dist. betw. uprights	B Inch	41	61	80		102	124	150		102	124
Stroke	C Inch	7.9	7.9	7.9		7.9	7.9	7.9		7.9	7.9
Distance table/ram	E Inch	15.7	15.7	15.7		15.7	15.7	15.7		15.7	15.7
Gap	D Inch	15.7	15.7	15.7		15.7	15.7	15.7		15.7	15.7
Table width	F Inch	4.7	4.7	4.7		4.7	4.7	4.7		4.7	4.7
Max. load table	Ton/ft	68	68	68		68	68	68		68	68
Working height	Inch	38.2	38.2	38.2		38.2	38.2	38.2		38.2	38.2
Approach speed*	Inch/min	307	307	307	378	307	307	307	425	307	307
Working speed**	Inch/min	24	24	24	52	28	28	28	52	28	28
Return speed	Inch/min	272	272	272	472	272	272	272	472	272	272
Motor	HP	15	15	15	20	20	20	20	30	20	20
Weight	lbs	12,125	13,230	14,340		20,950	24,255	26,460		20,950	24,255
Oil tank	Gal	33	33	33		66	66	66		66	66

Type		135/42	135/Turbo	170/30	170/40	170/42	170/51	170/Turbo	220/30	220/30 Plus	220/40	220/40 Plus
Pressing force	Ton	150	150	190	190	190	190	190	240	240	240	240
Pressure	Bar	290	290	285	285	285	285	285	285	285	285	285
Working length	A Inch	168		120	157	168	200		120	120	157	157
Dist. betw. uprights	B Inch	150		102	124	150	179		102	102	124	124
Stroke	C Inch	7.9		7.9	7.9	7.9	7.9		7.9	11.8	7.9	11.8
Distance table/ram	E Inch	15.7		15.7	15.7	15.7	15.7		15.7	22.4	15.7	22.4
Gap	D Inch	15.7		15.7	15.7	15.7	15.7		15.7	15.7	15.7	15.7
Table width	F Inch	4.7		4.7	4.7	4.7	4.7		4.7	7.9	4.7	7.9
Max. load table	Ton/ft	68		68	68	68	68		68	85	68	85
Working height	Inch	38.2		38.2	38.2	38.2	40.1		38.2	39.3	38.2	39.3
Approach speed*	Inch/min	307	425	236	236	236	236	425	283	283	283	283
Working speed**	Inch/min	28	52	28	28	28	28	52	50	50	50	50
Return speed	Inch/min	272	472	307	307	307	307	472	472	472	472	472
Motor	HP	20	30	30	30	30	30	50	50	50	50	50
Weight	lbs	26,460		24,355	28,670	31,975	43,000		27,565	28,665	33,075	34,180
Oil tank	Gal	66		92	92	92	92		92	92	92	92

* For CE-countries only if the machine is equipped with an optional safety system. ** For CE-countries working speed is limited to safety norm. Different combinations of stroke and daylight are available in our standard range by steps of +100 mm. Specifications subject to change without prior notice.

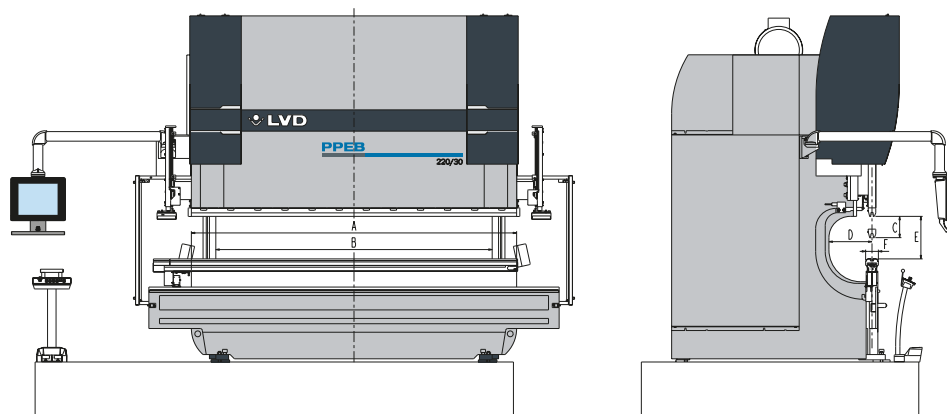

Type		220/42	220/42 Plus	220/51	220/51 Plus	220/61	220/61 Plus	320/30	320/40	320/45	320/51	320/61
Pressing force	Ton	240	240	240	240	240	240	350	350	350	350	350
Pressure	Bar	285	285	285	285	285	285	285	285	285	285	285
Working length	A Inch	168	168	200	200	240	240	120	157	177	200	240
Dist. betw. uprights	B Inch	150	150	179	179	198	198	102	124	150	168	198
Stroke	C Inch	7.9	11.8	7.9	11.8	7.9	11.8	11.8	11.8	11.8	11.8	11.8
Distance table/ram	E Inch	15.7	22.4	15.7	22.4	15.7	22.4	22.4	22.4	22.4	22.4	22.4
Gap	D Inch	15.7	15.7	15.7	15.7	15.7	15.7	15.7	15.7	15.7	15.7	15.7
Table width	F Inch	4.7	7.9	4.7	7.9	4.7	7.9	7.9	7.9	7.9	7.9	7.9
Max. load table	Ton/ft	68	85	68	85	68	85	85	85	85	85	85
Working height	Inch	38.2	39.3	40.3	41.5	40.3	41.5	39.3	39.3	39.3	40.7	45.8
Approach speed*	Inch/min	283	283	283	283	283	283	283	283	283	283	283
Working speed**	Inch/min	50	50	50	50	50	50	33	33	33	33	33
Return speed	Inch/min	472	472	472	472	472	472	307	307	307	307	307
Motor	HP	50	50	50	50	50	50	50	50	50	50	50
Weight	lbs	36,385	37,485	45,205	46,305	51,820	52,920	46,305	50,715	56,230	63,945	79,380
Oil tank	Gal	92	92	92	92	92	92	106	106	106	106	106

Type		400/40	400/45	400/51	400/61	500/40	500/45	500/51	500/61	640/45	640/61	640/81
Pressing force	Ton	440	440	440	440	550	550	550	550	700	700	700
Pressure	Bar	290	290	290	290	290	290	290	290	290	290	290
Working length	A Inch	160	177	200	240	160	177	200	240	177	240	315
Dist. betw. uprights	B Inch	124	150	168	198	124	148	159	198	148	198	277
Stroke	C Inch	11.8	11.8	11.8	11.8	11.8	11.8	11.8	11.8	11.8	11.8	11.8
Distance table/ram	E Inch	22.4	22.4	22.4	22.4	22.4	22.4	22.4	22.4	22.4	22.4	22.4
Gap	D Inch	15.7	15.7	15.7	15.7	15.7	15.7	15.7	15.7	15.7	15.7	15.7
Table width	F Inch	7.9	7.9	7.9	7.9	7.9	7.9	7.9	7.9	7.9	7.9	7.9
Max. load table	Ton/ft	85	85	85	85	85	85	85	85	85	85	85
Working height	Inch	38.2	38.2	38.25	38.2	38.2	38.2	38.2	38.2	38.2	38.2	38.2
Approach speed*	Inch/min	236	236	236	236	236	236	236	236	212	212	212
Working speed**	Inch/min	26	26	26	26	21	21	21	21	21	21	21
Return speed	Inch/min	283	283	283	283	189	189	189	189	236	236	236
Motor	HP	50	50	50	50	50	50	50	50	75	75	75
Weight	lbs	67,255	70,560	74,970	81,585	86,880	93,050	96,625	108,970	108,710	125,685	157,770
Oil tank	Gal	132	132	132	132	172	172	172	172	225	225	225

SOFTWARE INTEGRATION

LVD's database-driven CADMAN® suite software integrates sheet metalworking processes, production control, communication and management. It provides users real-time data to make informed choices, enabling optimized programming and maximized throughput in the workshop.

CADMAN-JOB

CADMAN-JOB connects the front office intakes and processing of orders with the shop floor operations. The software creates or imports production orders from an ERP system allowing users to generate production jobs for bending.



CADMAN-B

After importing a 3D CAD part, CADMAN-B automatically defines inclined, parallel and multi-bends, as well as hemming and preliminary bends. The module can visualize the complete bend process with start to finish collision detection, gauge positions and tool setups.

Touch-B control

The speed and simplicity of touch screen technology is combined with the power of a CNC control. Touch-B works with the centralized CADMAN database, is compatible with CADMAN-JOB and CADMAN-B and has access to LVD's customer support helpdesk.



Touch-i4

Touch-i4 is an industrial-grade Windows®-based tablet that provides an overview of the entire fabrication workshop. It collects real-time information from your LVD machine(s) powered by the centralized CADMAN database.

CADMAN-SDI

The Smart Drawing Importer allows fast CAD file import. CADMAN-SDI converts the file to OSM and stores it in the central database. All cost drivers are displayed and can be exported to create an accurate cost estimate.

LVD North America
12975 Clarence Center Rd.
AKRON NY 14001, UNITED STATES
Tel. +1 716 542 4511 - marketing.us@lvdgroup.com - www.lvdgroup.com

LVD North America is the trade name of the Sales & Service division of Stripit, Inc.

