



L A S E R C U T T I N G M A C H I N E S

ORION SERIES



Cost-Effective Laser Processing

The Orion CO₂ laser cutting system combines advanced laser cutting technology with a streamlined design to offer an intelligent, cost-effective solution for today's laser processing needs.

The most capable laser machine in its class, Orion makes advanced laser cutting technology practical for all shops and for entry-level users.

A highly reliable machine, it provides impressive cutting capabilities in a compact, hybrid-style system able to process sheet sizes up to 60" x 120" or 80" x 160" without repositioning.

Engineered for efficiency and ease of use, Orion combines quick set-up and features such as programmable high-pressure oxide-free cutting and automatic cutting gas selection to provide consistent accuracy and high productivity.

Choose the Orion model that best suits your application requirements:

Orion: A cost-effective design ideal for entry-level users as well as cell manufacturing.

Orion Plus: Offers increased functionality and opens the door to the world of automation with an optional fully automatic load/unload system and/or compact tower unit.

Both the Orion and Orion Plus feature a fully integrated Fanuc laser package for complete control of the cutting process. The integration of laser source, CNC control, AC digital motors and amplifiers ensures a high degree of reliability and superior processing speed.

Other features include a fully programmable 11.5" Z-axis for efficient cutting of pre-bent parts or profiles, an edge function for clean-cut processing of sharp corners, and optional CADMAN-L 3D offline programming software.

LVD's Orion—an intelligent choice for fabricators that want proven laser technology in a user friendly, economical machine.



Orion

- Compact hybrid-style laser system
- Handles sheet sizes up to 60"x 120" for Orion 3015 and 80"x 160" for Orion 4020
- Low operation and maintenance costs
- Easy to use and quick to set up
- Equipped with a single system Fanuc laser package, incorporating laser source, control, motors and AC drive amplifiers
- Fanuc CNC control features 9.5" color screen, large memory capacity
- Features an extensive database of cutting technology for processing a wide range of materials
- Features dust collector filter, fences and light guard as standard equipment



Orion Series – compact hybrid-style laser



Orion 3015

- Forms an extremely flexible manufacturing cell in combination with a punch press and a press brake for the production of a wide variety of components
- Offers a choice of 2500-Watt or 4000-Watt laser source
- Highly rigid design with precision drives ensures high accuracy cutting
- Optional CADMAN-L 3D software maximizes flexibility and productivity
- Optional automated load/unload system or Compact Tower system for Orion Plus

Consistently Accurate Cutting



Integrated laser source and control

Orion Series models are engineered to provide consistently high-quality processing results in a system that is easy to set-up and operate.

- A standard laser cutting head accommodates a 5-inch or 7.5-inch quick-change lens for fast changeover and minimal set-up. These water-cooled quick-change lenses can be installed or exchanged very easily, using a self-centering system. Lens calibration is programmable and quick to achieve.
- A high-pressure cutting head delivers exceptionally clean cuts. A crash-protection system protects the head from damage after collision with the workpiece.
- A total power control feature automatically adjusts the laser power in relation to the cutting speed, ensuring an optimal cut at every contour width and minimizing the heat-affected zone.

- The machine's edge function feature processes sharp corners cleanly, particularly in thicker materials.

Efficient Operation

Orion is designed to be easy to use and efficient to operate with low maintenance and operating costs. Design advantages include:

- Compact rugged frame construction features a crossbeam base structure for easy installation. No special foundation is required.
- Ergonomic design provides user with full access on three sides enabling quick and simple loading and unloading, and providing good visibility during the cutting process. The machine table is positioned at working height. The operator has easy access to the cutting head while at the machine control.
- Built-in exhaust system removes fumes and molten material in an environmentally-friendly manner.



Quick-change, self-centering lens cartridges



Integrated Fanuc package

RENOWNED RELIABILITY

Full Cutting Control

LVD's Orion offers the proven reliability of Fanuc integrated laser and CNC control, providing the user full control over the cutting process.

- The RF excited fast axial flow CO₂ laser, CNC control, system drives and motors are fully integrated, ensuring high reliability, as well as low operating and maintenance costs.

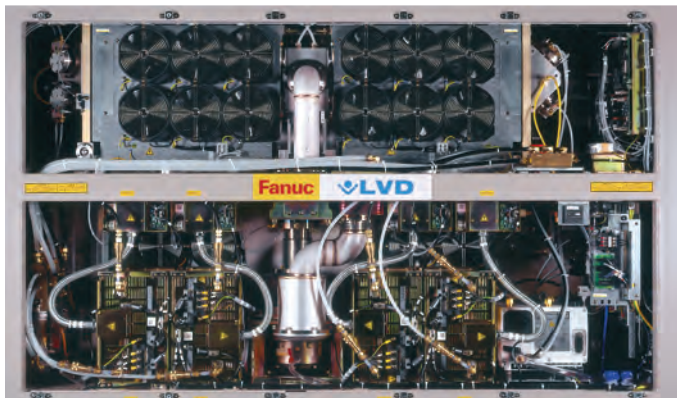

Fast axial flow CO₂ laser

- The integrated Fanuc CNC control provides perfect reproduction of programmed contours, producing acute angles at high speed. The laser power is matched to the vectorial speeds to achieve a constant cut width and a small heat-affected zone.
- All parameters, diagnostic and start-up procedures are conveniently displayed on the control screen.
- The 32-bit control features powerful mathematical capabilities and an extensive material library.
- Orion is available with a powerful 2.5 kW or 4 kW laser source.

CADMAN®

Robust Offline Software

Optional CADMAN-L 3D offline programming software provides a comprehensive laser-cutting CAM package, featuring:

- Flexible lead-in/lead-outs for every kind of contour
- Advanced common line cutting
- Collision avoidance and automatic cutting sequence
- Complete flexibility to manually cut and nest laser parts
- DXF, DWG, IGES, SAT, MI file importation
- Automatic or interactive determination of cutting sequences
- Interactive or optional automatic nesting of different parts and shapes
- High-speed communications via networking or DNC link

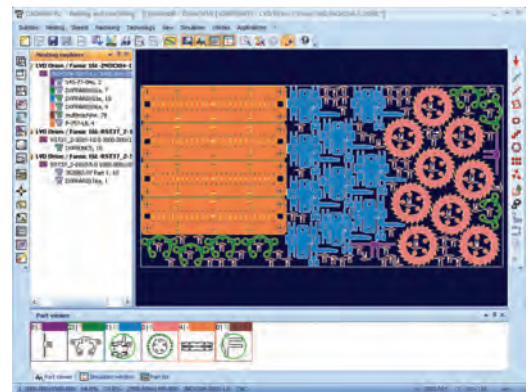

Interactive or automatic nesting

Enhanced Performance

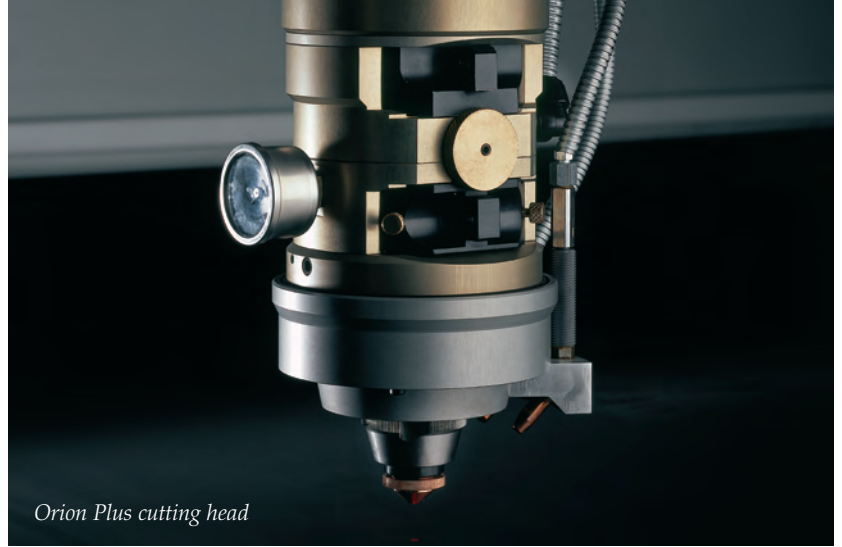

Orion Plus cutting head



Control screens simplify programming of the automatic load/unload system

Orion Plus provides enhanced features for a higher level of performance.

In addition to the standard features found on Orion, the Plus model offers automatic focal positioning, greater process control functionality, and optional automatic load/unload system or optional Compact Tower.

Orion Plus features include:

- **Process Control** to automatically sense piercing times and detect and control plasma when cutting stainless steel and aluminum. This feature maximizes processing time and minimizes part damage due to loss of cut.

- **NC Focus** provides programmable adjustment of the focal position, eliminating the need for operator intervention to adjust the focal position.
- **Air/Oil Spray device** to safely disperse splatter and lubricate the sheet when processing thicker materials, ensuring part quality is maintained
- **Automatic shut down**
- **Automatic material workclamps**



Maximizing Productivity

Orion Plus is engineered as automation ready and can be expanded with the addition of various components to form a compact, fully automated system.

LVD's automation solutions improve workflow and reduce material handling as well as secondary processing time to maximize machine productivity. Select from a space-saving automated load/unload system or a full material storage and retrieval unit.

LVD's automated systems provide:

- Simple, compact design
- High flexibility to process a high volume of dissimilar parts
- Highly reliable automated production
- Continuous production for "lights out" manufacturing
- Fully automatic loading and unloading
- Safe, efficient handling of workpieces



Orion 3015 Plus with automatic load/unload system

Material Handling & Storage Solutions

Automation further expands the flexibility and productivity of an Orion laser cutting system.

The addition of automation provides fast, efficient processing of materials for continuous, uninterrupted workflow.

A graphical user interface simplifies programming and makes operation of the automated system easy and intuitive.

LVD automation options are designed to be compact, affordable and easy to install and implement. Choose the level of automation appropriate for your requirements: an automatic load/unload system or fully integrated material storage and retrieval unit.

Automatic Load/Unload

An automatic load/unload system eliminates manual sheet handling and increases machine productivity and efficiency. The system permits unattended production, freeing the operator to perform other tasks. Its compact design requires minimal floor space.

LVD's automatic load/unload system handles sheets as large as 120" x 60" and material thicknesses up to 0.50" with a maximum pallet capacity of 5511 lbs.



Automatic load/unload system



Consider an automatic load/unload system for:

- Flexible processing
- Large volume applications with common material type, thickness and size
- Handling of oversized or heavy workpieces
- Optimizing labor resources
- A compact, economical automation solution

Compact Tower

For the ultimate in automated laser processing, LVD's optional Compact Tower (CT-L) system creates a productive, flexible manufacturing cell capable of operating "lights out."

The tower system, working in concert with the material handling unit, provides full capabilities for loading and unloading, and includes a shelving unit for storing raw material and finished parts.

- Designed as affordable mid-level automation, the space-saving system provides increased productivity by

allowing optimal material flow and unattended operation with uninterrupted processing of high-quality laser cut parts.

- The CT-L system provides full capabilities for loading, unloading, and storage of raw material and finished parts.
- Automated material handling system provides unmanned, "lights out" production in a compact cell environment.
- LVD's CT-L system handles sheets as large as 120" x 60" and material thicknesses up to 0.625" with a maximum load/unload pallet storage capacity of 6613 lbs.
- The CT-L system is offered in three configurations: 4-pallet, 6-pallet and 10-pallet units.

Compact Tower System

Pallet construction on the CT-L is designed for compact set up and convenient forklift manipulation.

Job change over cycle:

- Previous job in the joblist finishes.
- The completed pallet of processed parts is moved from the unloading station to the intermediate station.

- An empty unload pallet is moved from the tower into the unload station.
- The pallet from the loading station is then moved into the free space created from the previous step.
- A full load pallet is then moved from the tower into the loading station.
- Next job in the joblist commences.

In this manner, the Compact Tower continues delivering material to the machine and evacuating skeletons.

The operator can choose to evacuate or leave the pallet in the intermediate station. The system will automatically move the full unload pallet to the free space available.

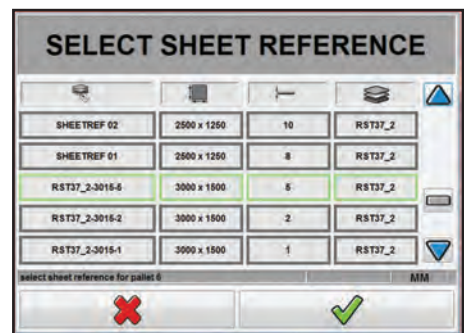

Intuitive GUI screens for the CT-L system provide easy to understand step by step information for loading, unloading and storage



TECHNICAL SPECIFICATIONS

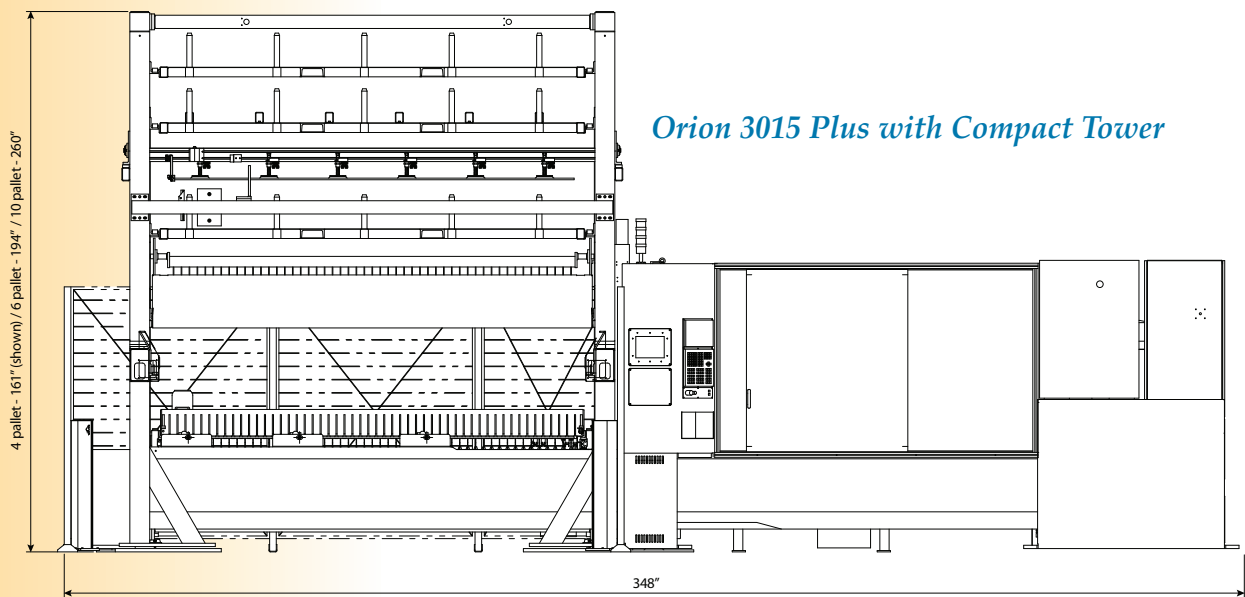
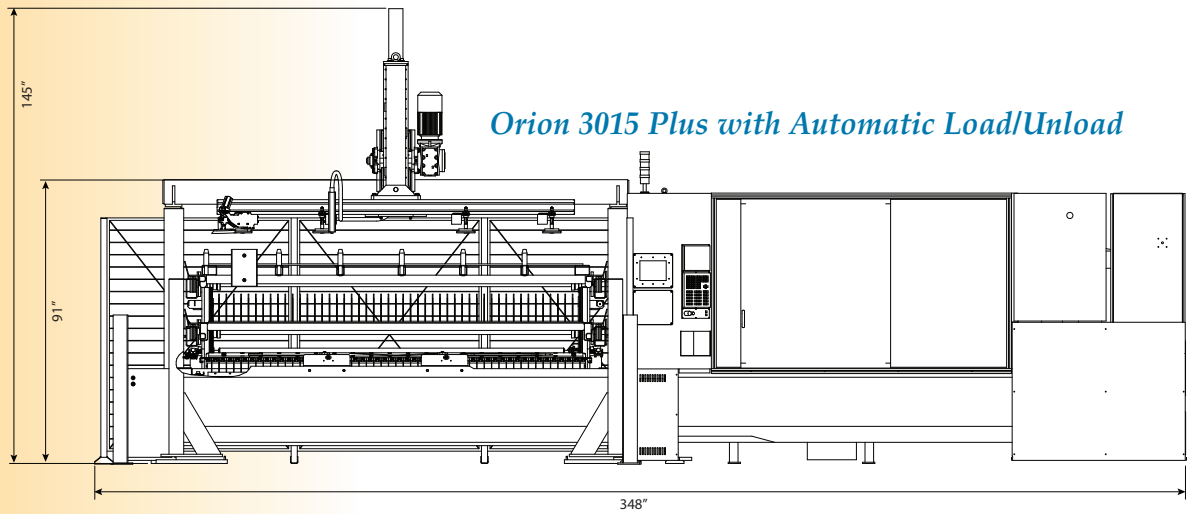
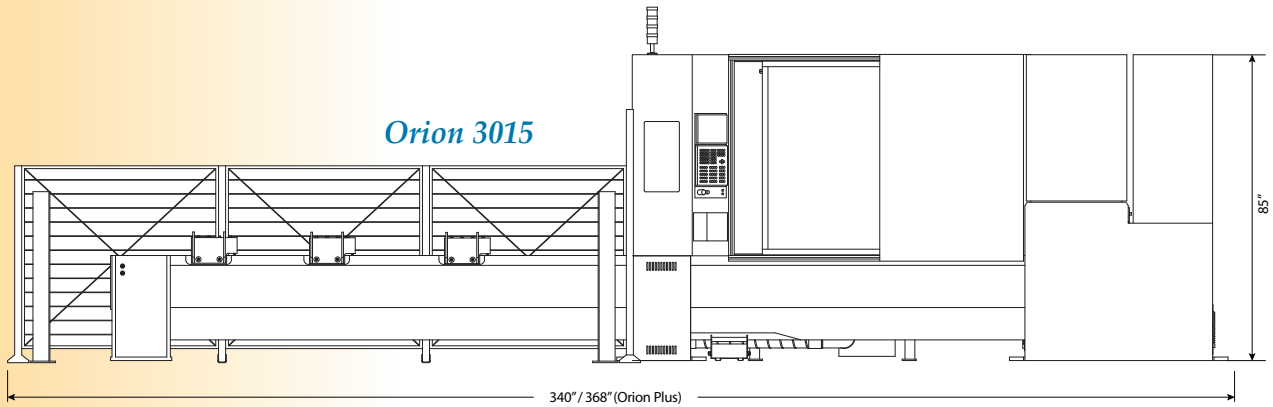

| Machine | Orion 3015 | Orion 3015 Plus | Orion 4020 | Orion 4020 Plus |
|---|--|----------------------------|-------------------|------------------------|
| Max. Sheet Size | 60" x 120" | 60" x 120" | 160" x 80" | 160" x 80" |
| Max. Sheet Weight | 1250 lbs. | 1250 lbs. | 2204 lbs. | 2204 lbs. |
| X-Axis Travel | 121" | 121" | 161" | 161" |
| Y-Axis Travel | 61" | 61" | 81" | 81" |
| Z-Axis Travel | 11.5" | 9.5" ⁽¹⁾ (3.9") | 11.5" | 9.5" |
| Memory | 2 Mb | 2 Mb | 2 Mb | 2 Mb |
| Display | Color | Color | Color | Color |
| Max. Positioning Speed | | | | |
| X,Y-axis | 3935"/min. | 3935"/min. | 3935"/min. | 3935"/min. |
| Z-axis | 700"/min. | 700"/min. | 700"/min. | 700"/min. |
| Repetitive Accuracy | ± 0.0008" | ± 0.0008" | ± 0.0008" | ± 0.0008" |
| Positioning Accuracy ⁽²⁾ | ± 0.002" | ± 0.002" | ± 0.002" | ± 0.002" |
| Laser | 2500 W | 4000 W | | |
| Type | Fanuc HF excited CO ₂ laser | | | |
| Laser Power (± 2 %) | 2500W | 4000W | | |
| Range | 100-2500W | 100-4000W | | |
| Output Stability | ± 1 % ± 2 % | | | |
| Wave Length | 10,6 µm | | | |
| Pulse Frequency | 5 Hz - 2 kHz | | | |
| Laser Gas | 10 l/hour | | | |
| Cooling Water | Sealed circuit | | | |
|  | | | | |
| Material Capacities | | | | |
| Steel | 5/8" | 5/8" | | |
| Stainless Steel (N ₂) | 3/8" | 1/2" | | |
| Aluminum | 3/16" | 3/8" | | |
| General Specifications (For stand alone machines) | | | | |
| Machine Dimensions | Orion 3015 | Orion 3015 Plus | Orion 4020 | Orion 4020 Plus |
| L | 340" | 368" | 454" | 454" |
| W | 173" | 173" | 190" | 190" |
| H | 91" | 91" | 91" | 91" |
| Weight | 25353 lbs. | 28660 lbs. | 33069 lbs. | 33069 lbs. |
| Automatic load/unload device | | | | |
| Max. Sheet Size | 120" x 60" x 0.47" | | | |
| Max. Stack Weight | 5511 lbs. | | | |
| Max. Stack Height | 3.9" | | | |
| Weight | 10582 lbs. | | | |
| Footprint (Orion Plus including autoloader unit) | | | | |
| L | 350" | | | |
| W | 259" | | | |
| H | 145" | | | |
| Compact Tower | | | | |
| Max. Sheet Dimensions | 120" x 60" | | | |
| Min. Sheet Dimensions | 39" x 39" | | | |
| Max. Weight of Pallet | 6613 lbs. | | | |
| Max. Height of Pallet | 9.4" including pallet | | | |
| Footprint | | | | |
| L | 348" | | | |
| W | 283" | | | |
| Height of Unit: | | | | |
| 4-pallet | 161" | | | |
| 6-pallet | 194" | | | |
| 10-pallet | 260" | | | |

(1) Reduced Z-axis travel with load/unload system

(2) Achievable workpiece accuracy depends on the type of workpiece, pre-treatment and sheet size, as well as other variables. According to VDI/DGQ 3441. Specifications subject to change without prior notice.

HEADQUARTERS

Strippit Inc.

12975 Clarence Center Rd.
USA-AKRON NY 14001
UNITED STATES
Tel. + 1 716 542 4511
Fax + 1 716 542 5957
e-mail: marketing@strippit.com

LVD Company n.v.

Nijverheidslaan 2
B-8560 GULLEGEM
BELGIUM
Tel.+ 32 56 43 05 11
Fax + 32 56 43 25 00
e-mail: marketing@lvd.be

JOINT VENTURES

LVD-HD

Huangshi City,
Hubel Province, China

SUBSIDIARIES*

LVD BeNeLux nv

Gullegem, Belgium

LVD do Brasil Ltda.

Joinville, Brazil

LVD GmbH

Lahr, Germany

LVD Italia s.r.l.

Parma, Italy

LVD Korea

Inchon City, Korea

LVD Ltd.

Oxfordshire, United Kingdom

LVD Malaysia Sdn Bhd

Shah Alam, Malaysia

LVD Polska Sp. z o.o.

Kedzierzyn-Kozle, Poland

LVD S2/S3

Tornala, Slovakia

LVD s.a.

Raismes, France

LVD-Strippit Shanghai Co. , Ltd.

Shanghai, China

LVD SWE-NOR A/S

Oslo, Norway

LVD Thailand Limited

Bangkok, Thailand

Magal LVD India Pvt. Ltd

Bangalore, India

P.T. LVD Center

Jakarta, Indonesia

**For full address details of your local subsidiary or agent, or to download the latest literature, please visit our website:*

www.lvdgroup.com